

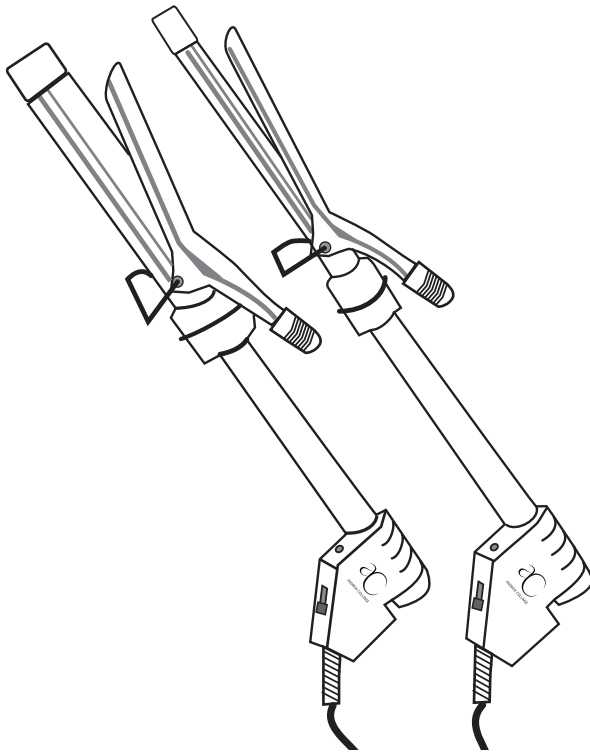

ANDREW COLLINGE



MODEL NO.AC1CI, AC2CI, AC1CIG or AC2CIG

INSTRUCTIONS AND WARRANTY

PROFESSIONAL SWIVEL CURLING IRON

IMPORTANT SAFEGUARDS

When using electrical appliances, especially when children are present, basic safety precautions should always be followed, including the following:

READ ALL INSTRUCTIONS BEFORE USING KEEP AWAY FROM WATER

DANGER: As with most electrical appliances, electrical parts are electrically live even when the switch is off.

To reduce the risk of death by electrical shock:

1. Always "unplug it" immediately after using.
2. Do not use while bathing, in damp rooms, or over a hand basin or vessel filled with water.
3. Do not place or store appliance where it can fall or be pulled into tub or sink.
4. Do not place in or drop into water or other liquid.
5. If an appliance falls into water, "unplug it" immediately. Do not reach into the water.
6. Never use the appliance with wet hands. Never immerse appliance in water. Never hold this appliance under running water or allow it to become wet (as in splashing).

WARNING: To reduce the risk of burns, electrocution, fire, or injury to persons:

1. Do not leave appliance unattended while it is operating or is plugged in.
2. Close supervision is necessary when this appliance is used by, on, or near children or invalids.
3. Use this appliance only for its intended use as described in this manual. Do not use attachments not recommended by the manufacturer.
4. Never operate this appliance if it has a damaged cord or plug, if it is not working properly, if it has been dropped or damaged in any manner, or dropped into water. Contact Consumer Service for examination and repair or mechanical adjustment.
5. Keep the cord away from hot or heated surfaces. Do not wrap the cord around the appliance.
6. Never use while sleeping or while drowsy.

7. Never drop or insert any object into any opening.
8. Do not use outdoors or operate where aerosol (spray) products are being used. Do not operate where oxygen is being administered.
9. Place unit on a level surface to use. Do not use on a bed or any soft surface where unit could tip over easily or be covered up.
10. Unit is hot when in use. To avoid burn hazard, do not touch the hot plates; they are hot.
11. Do not use an extension cord with this appliance.
12. Most foreign countries have unstable voltage which may cause your appliance to shut off due to irregular voltage. This does not harm the appliance or indicate a defective product.
13. Before plugging in, read the information about dual voltage contained in the instruction section of this manual.

SAVE THESE INSTRUCTIONS

THIS PRODUCT IS FOR HOUSEHOLD USE ONLY
THIS IS NOT A TOY

ADDITIONAL IMPORTANT SAFEGUARDS

1. The Barrel of this Curling Iron is hot when in use. Do not let eyes or bare skin touch heated surfaces.
2. Do not touch Barrel with fingertips.
3. Do not place the heated Curling Iron directly on any surface while it is hot or plugged in. Use the Safety Stand provided.
4. For shorter hair, place a thin plastic comb between scalp and Curling Iron Barrel to avoid touching scalp.
5. Do not use styling products in the hair prior to curling.
6. Test on a small section of hair before using.

NOTE: Use on dry hair only. Do not use this appliance on synthetic hair or wigs.

WARNING: Keep the cord away from hot metal surfaces.

Polarized Plug

This appliance has a polarized plug (one blade is wider than the other.) To reduce the risk of electric shock, this plug is intended to fit into a polarized outlet only one way. If the plug does not fit fully into the outlet, reverse the plug. If it still does not fit, contact a qualified electrician. Do not attempt to defeat this safety feature.

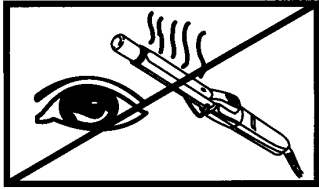

CAUTION: THIS PRODUCT CAN BURN EYES



KEEP AWAY FROM CHILDREN

Getting to Know Your PROFESSIONAL SWIVEL Curling Iron

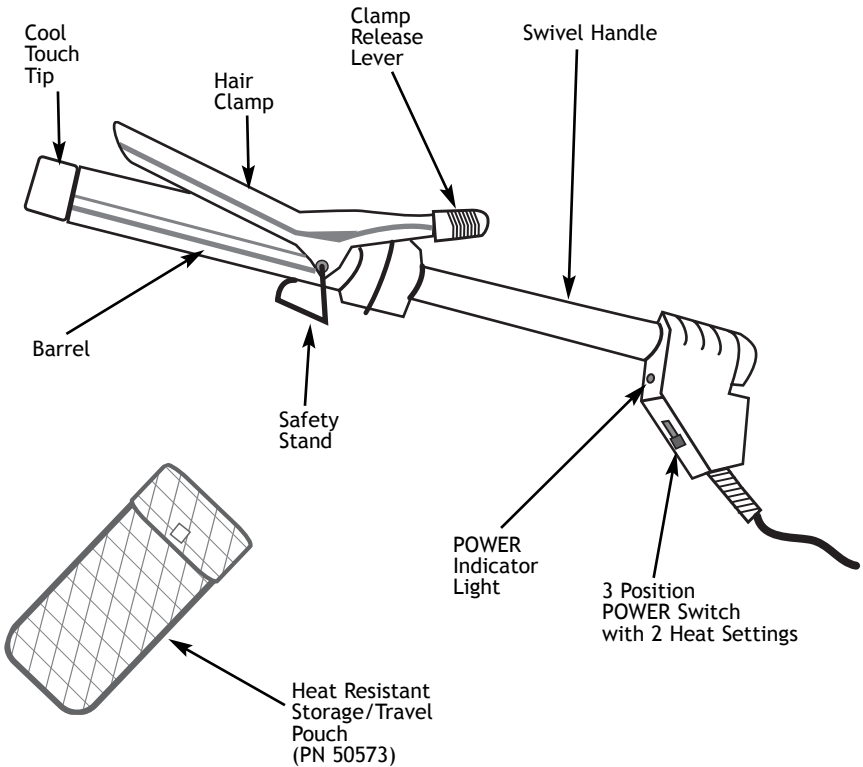

OPERATING THE PROFESSIONAL SWIVEL CURLING IRON

When used correctly, the Professional Swivel Curling Iron will help you to achieve the latest fashionable styles. With this salon-quality tool, you will be able to style your hair in no time!

BEFORE STYLING THE HAIR

IMPORTANT: Before styling, ensure that the hair is clean, dry, and tangle-free.

We do not recommend using styling products in the hair prior to curling. Some products are flammable and will cause the hair to stick to the Curling Iron. Build-up from products will coat the Barrel and Clamp and prevent the hair from curling efficiently. Use styling/shine products after the hair is curled.

You may notice a metallic smell the first time using the Curling Iron. This is normal and will cease with use.

DUAL VOLTAGE: This appliance utilizes a positive temperature coefficient (PTC) heating element and operates over a range of voltages.

Confirm the voltage available at each location before using the appliance.

For connection to a 240-volt supply or above, use an attachment plug adaptor (not included) of the proper configuration for the power supply receptacle.

CURLING IRON OPERATION

CAUTION:

- Do not rest Curling Iron on its side.
- NEVER leave the Curling Iron ON and unattended.
- Barrel is hot. Do not touch with fingers.

Operation

1. Plug the Power Cord into a standard Household AC outlet.
2. Slide the POWER Switch to the desired heat setting (HI or LO.) The red POWER Indicator Light will illuminate.
3. It will take approximately 2 minutes for the Curling Iron to heat up. You may rest the supervised Curling Iron on its Safety Stand on a smooth, flat surface during this time.
4. Style your hair as desired.
5. When you are finished using the Curling Iron, slide the POWER Switch to OFF. Unplug the unit.

STYLING TIPS

Notice: The Curling Iron uses a ceramic PTC heating element for fast heat-up and constant temperature. Care should always be used when hair is in contact with the hot Barrel of the Curling Iron.

Steam

1. If product build-up is on the hair, or a conditioner has been used, you will notice a slight amount of steam coming from the Curling Iron. This is normal.

However, if large amounts of steam are forming, discontinue curling. Slide POWER Switch to OFF and unplug the unit.

2. Wash your hair with a clarifying shampoo to remove the build-up. Condition hair with a light conditioner as necessary, and dry the hair thoroughly.
3. Proceed in curling hair.

Steaming or Singeing?

When the hair is steaming, there will be a slight product odor and white steam. This is normal. When the hair is singeing, there will be a strong odor and light to dark "smoke." You can tell the hair is damaged from excessive heat when the hair frizzles and possibly discolors.

Frazzled Hair

Over-curling can frazzle hair! Some hair strands will form kinks, unlike the natural curl of the hair.



This is the first sign of hair damage. Discontinue curling immediately.

WARNING: DO NOT TRY TO CURL DAMAGED HAIR!

Chemically Treated Hair

1. Use CAUTION when curling chemically treated, colored, or permed hair.
2. Cut down the time used for curling chemically treated, colored, or permed hair.
3. Smaller sections are better for thick or resistant hair.

STYLING

1. Divide hair into sections no more than 2 inches wide before starting.
2. Keep the hair strand smooth by brushing or combing through the section while holding the ends taut with the other hand.
3. Taking one section at a time, place the ends of hair over the Barrel with the Clamp open.
4. Close the Clamp making sure that the ends extend just a tiny bit beyond the Clamp.
See Fig. 1.

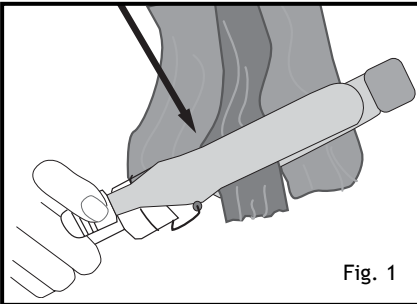

Fig. 1

5. Grasp the Cool Touch Tip with the other hand to roll hair
6. Keep the section of hair taut as you wind it around the hot Barrel by slowly turning the Handle. Wind the curl toward your scalp as far as you wish to go without touching scalp with the hot Barrel.
7. Hold the curl in place for the needed length of time to achieve the desired effect (See following section on TIMING.)

8. When you are ready to release curl, unwind about half a turn (for longer hair unwind a bit more) and push down on the Clamp Release Lever to open the Clamp.
9. Gently withdraw the Barrel from the center of the curl.
10. Allow curl to cool and try not to disturb curls as you proceed in the same manner around the whole head.

Timing

1. The Curling Iron uses a ceramic PTC heating element for fast heat-up and constant temperature. You will need to test how long it takes to curl your hair from the roots to the ends.
2. First test an inconspicuous section of your hair. Use thinner sections for thick, resistant hair.
3. **Begin timing at 5-8 seconds for fine, thin hair. Hold the curl in place for 9-12 seconds for thick or coarse hair.** Then release the curl and view the results. If more time is needed, skip to a new section of hair until you find the right time needed.

For Bouncy Flip-Up Curls

Clamp should be **under** the Barrel and **over** the section of hair at the start of the curl. See Fig. 2.

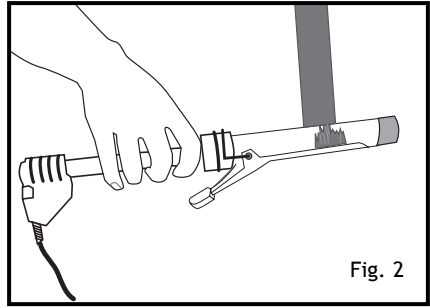

Fig. 2

For Curl-Under, Pageboy Curls

Clamp should be **over** the Barrel and **under** the hair section at the start of the curl. See Fig. 3.

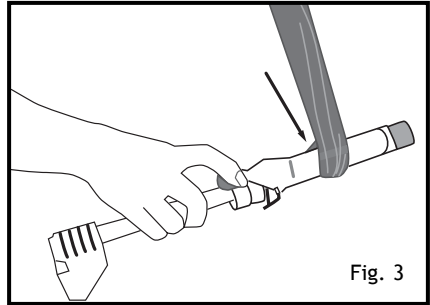

Fig. 3

Spiral Curls

Insert the hair near base of clamp where it meets the handle. Then wind the hair up the barrel towards the tip. See Fig. 4.

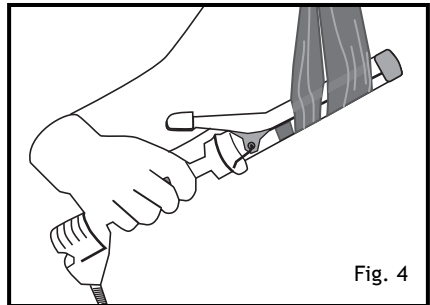

Fig. 4

For Tousled Hair

Create soft, tousled waves by curling each strand of hair in a random direction. Then, turn your head upside down, shake and gently scrunch hair with fingers. Return your head to an upright position and repeat for fullest volume.

USER MAINTENANCE INSTRUCTIONS

This appliance requires little maintenance. It contains no user-serviceable parts. Do not try to repair it yourself. Contact a qualified appliance repair technician if the product requires servicing.

Cleaning

WARNING: Always be sure Curling Iron is turned off, unplugged, and completely cool before cleaning.

1. Wipe plastic surfaces with a damp, soapy sponge.
2. For dust or dirt from the hair's natural oil or conditioner build up on Barrel, use a sponge with a small amount of shampoo.
3. Wipe remaining shampoo off Barrel with a clean damp sponge.
4. Do not immerse in water or any other liquid.
5. Make certain the Curling Iron is completely dry before using. Keep heated surfaces of the

Curling Iron clean and free of dust, dirt, and styling products.

Storage

NOTE: When not in use, make sure the Curling Iron is unplugged.

1. Slide the POWER Switch to the OFF position. The red POWER ON Light will turn off.
2. Unplug the Power Cord from the electrical outlet.
3. Allow the appliance to cool completely. Once the Curling Iron is cooled, store in a cool, dry location.
5. Never wrap the Power Cord around the Curling Iron, as this will cause the cord to wear prematurely and break. Check the Power Cord for wear and damage regularly, particularly where the cord enters the appliance and the plug.

CAUTION: If the cord of this appliance becomes damaged, refer to the Service and Repair section of the warranty.

REPLACEMENT PARTS

Replacement parts are available and may be purchased through our Consumer Relations Department by calling 1-800-934-7455, Mon-Fri. 9am-5pm Central Time, with Visa, Mastercard, Discover, or American Express. Please be ready to give the part number(s) when you call.

Or log into our website to order at: www.eSalton.com

ANDREW COLLINGE Professional Swivel Curling Iron (AC1CI, AC2CI, AC1CIG, or AC2CIG)

REPLACEMENT PARTS

<u>PART #</u>	<u>DESCRIPTION</u>
50573	Heat Resistant Storage/Travel Pouch

NOTES

LIMITED TWO YEAR WARRANTY

Warranty: This Andrew Collinge product is warranted by Salton, Inc. to be free from defects in materials or workmanship for a period of (2) years from the original purchase date. This product warranty covers only the original consumer purchaser of the product.

Warranty Coverage: This warranty is void if the product has been damaged by accident in shipment, unreasonable use, misuse, neglect, improper service, commercial use, repairs by unauthorized personnel, normal wear and tear, improper assembly, installation or maintenance abuse, or other causes not arising out of defects in materials or workmanship. This warranty is effective only if the product is purchased and operated in the USA, and does not extend to any units which have been used in violation of written instructions furnished with the product or to units which have been altered or modified or to damage to products or parts thereof which have had the serial number removed, altered, defaced, or rendered illegible.

Implied Warranties: ANY IMPLIED WARRANTIES WHICH THE PURCHASER MAY HAVE ARE LIMITED IN DURATION TO TWO (2) YEARS FROM THE DATE OF PURCHASE. Some states do not allow limitations on how long an implied warranty lasts, so the above limitation may not apply to you.

Warranty Performance: During the above two-year warranty period, a product with a defect will be either repaired or replaced with a reconditioned comparable model (at our option) when the product is returned to the Repair Center, or the purchase price refunded. The repaired or replacement product will be in warranty for the balance of the two-year warranty period and an additional one-month period. No charge will be made for such repair or replacement.

Service and Repair: Should the appliance malfunction, you should first call toll-free 1 (800) 934-7455 between the hours of 9:00 am and 5:00 pm Central Standard Time and ask for CONSUMER SERVICE stating that you are a consumer with a problem. Please refer to model number AC1CI, AC2CI, AC1CIG, or AC2CIG when you call.

In-Warranty Service (USA): For an appliance covered under the warranty period, no charge is made for service or postage. Call for return authorization 1 (800) 934-7455.

Out-of Warranty Service: A flat rate charge by model is made for out-of-warranty service. Include \$ 8.00 (U.S.) for return shipping and handling. We will notify you by mail of the amount of the charge for service and require you to pay in advance for the repair or replacement.

For Products Purchased in the USA, but Used in Canada: You may return the product insured, packaged with sufficient protection, and postage and insurance prepaid to the USA address listed below. Please note that all customs duty/brokerage fees, if any, must be paid by you and we will require you to pay the cost of customs duty/brokerage fees to us in advance of our performing any service.

Risk During Shipment: We cannot assume responsibility for loss or damage during incoming shipment. For your protection, carefully package the product for shipment and insure it with the carrier. Be sure to enclose the following items with your appliance: any accessories related to your problem, your full return address and daytime phone number, a note describing the problem you experienced, a copy of your sales receipt or other proof of purchase to determine warranty status. C.O.D. shipments cannot be accepted.

To return the appliance, ship to:

ATTN: Repair Center
Salton, Inc.
708 South Missouri Street
Macon, MO 63552

To contact us, please write to, call, or email:

Salton, Inc.
P.O. Box 1637
Columbia, MO 65205-7366
1 (800) 934-7455
E-mail: Salton@saltonusa.com

Limitation of Remedies: No representative or person is authorized to assume for Salton, Inc. any other liability in connection with the sale of our products. There shall be no claims for defects or failure of performance or product failure under any theory of tort, contract or commercial law including, but not limited to negligence, gross negligence, strict liability, breach of warranty and breach of contract. Repair, replacement or refund shall be the sole remedy of the purchaser under this warranty, and **in no event shall Salton be liable for any incidental or consequential damages, losses or expenses.** Some states do not allow the exclusion or limitation of incidental or consequential damages, so the above limitation or exclusion may not apply to you.

Legal Rights: This warranty gives you specific legal rights, and you may also have other rights which vary from state to state.

For more information on Salton products: visit our website: www.eSalton.com

©2003 Salton, Inc. All rights reserved.
Made in China

P/N 61353
Printed in China